

Pedestrian stacker truck 1.45 - 2.0 ton



BT staxio

W-series

SWE145

SWE160

SWE200



Pedestrian stacker

Specifications				SWE145	SWE160	SWE200	
Identification	1.1	Manufacturer		Toyota	Toyota	Toyota	
	1.2	Model		SWE145	SWE160	SWE200	
	1.3	Drive		Electric	Electric	Electric	
	1.4	Operator type		Pedestrian	Pedestrian	Pedestrian	
	1.5	Load capacity/rated load	Q	kg	1450	1600	2000
	1.6	Load center	c	mm	600	600	600
	1.7	Load distance, centre of support arm wheel to face of forks	x	mm	649	649	638
	1.8	Wheelbase	y	mm	1344	1344	1344
	Weight	2.1	Service weight incl. battery		kg	1439	1439
2.2		Axle load, with load, drive/castor/fork wheel		kg	510/481/1898	580/416/2043	600/521/2539
2.3		Axle load, without load, drive/castor/fork wheel		Kg	360/578/501	380/558/501	360/704/596
Wheels	3.1	Drive/castor/fork wheel		Polyurethane			
	3.2	Wheel size, front		mm	Ø 230	Ø 230	Ø 230
	3.3	Wheel size, rear		mm	Ø 85	Ø 85	Ø 85
	3.4	Additional wheel size		mm	Ø 125	Ø 125	Ø 125
	3.5	Wheels, number front/rear (x = driven wheels)			1x+2/4	1x+2/4	1x+2/4
	3.6	Track width, front	b ₁₀	mm	585	585	585
	3.7	Track width, rear	b ₁₁	mm	370	370	390
Dimensions	4.2	Height, mast lowered	h ₁	mm	1955	1955	1955
	4.3	Free lift	h ₂	mm	1478	1478	1378
	4.4	Lift	h ₃	mm	4060	4060	3960
		Lift height	h ₂₃	mm	4150	4150	4050
	4.5	Height, mast extended	h ₄	mm	4668	4668	4668
	4.9	Height of tiller in drive position, min./max.	h ₁₄	mm	869/1294	869/1294	869/1294
	4.15	Height, fork lowered	h ₁₃	mm	90	90	90
	4.19	Overall length	l ₁	mm	1999	1999	2010
	4.20	Length to face of forks	l ₂	mm	849	849	860
	4.21	Overall width	b ₁ /b ₂	mm	790/—	790/—	790/—
	4.22	Fork dimensions	s/e/l	mm	70/180/1150	70/180/1150	70/185/1150
	4.25	Width over forks	b ₅	mm	570	570	575
	4.32	Ground clearance, center of wheelbase	m ₂	mm	27,5	27,5	27,5
	4.33	Aisle width for pallets 1000x1200 crossways	A _{st}	mm	2486	2486	2493
4.34	Aisle width for pallets 800x1200 lengthways	A _{st}	mm	2385	2385	2394	
4.35	Turning radius	W _g	mm	1504	1504	1504	
Performance data	5.1	Travel speed, with/without load		km/h	6,0/6,0	6,0/6,0	6,0/6,0
	5.2	Lift speed, with/without load		m/s	0,17/0,33	0,17/0,33	0,13/0,24
	5.3	Lowering speed, with/without load		m/s	0,45/0,45	0,45/0,45	0,45/0,45
	5.8	Max. gradeability, with/without load		%	8/12	8/12	8/12
	5.9	Acceleration time (over 10 m)		s	7,1	7,2	7,4
	5.10	Service brake			Electromagnetic	Electromagnetic	Electromagnetic
Electric motor	6.1	Drive motor rating (S2 60min)			1,8	1,8	1,8
	6.2	Lift motor rating (S3 15%)		kW	3	3	3
	6.4	Battery voltage, nominal capacity K _s		V/Ah	24/300	24/300	24/300
	6.5	Battery weight		kg	195-270	195-270	195-270
	6.6	Energy consumption acc to VDI cycle		kWh/h	1,078	1,078	1,078
	Others	8.1	Type of drive control			Variable AC	Variable AC
8.4		Sound level at the driver's ear according to EN 12 053		dB (A)	66	66	67

1) Measured according to company standard.
Data is based on standard truck and small battery.

*) Further alternatives are available and will produce other values.

Data is based on standard configurations: Small battery compartment, h₂₃ = 4150 mm (SWE145/160) and 4050 mm (SWE200) Triplex HiLo mast.

All data are based on table configuration. Other configurations may give other values.

Truck performance and dimensions are nominal and subject to tolerances.

Toyota Material Handling products and specifications are subject to change without notice.

Battery dependent dimensions

Dimensions		Battery		SWE145				SWE160				SWE200			
				Lift out		Sideways		Lift out		Sideways		Lift out		Sideways	
				S	L*	S	L*	S	L*	S	L*	S	L*	S	L*
1.9	Wheelbase	y	mm	1344	1441	1344	1441	1344	1441	1344	1441	1344	1441	1344	1441
4.19	Overall length	l_1	mm	1999	2096	1999	2096	1999	2096	1999	2096	2010	2107	2010	2107
4.20	Length to face of forks	l_2	mm	849	946	849	946	849	946	849	946	860	957	860	957
4.33	Aisle width for pallets 1000x1200 crossways	A_{st}	mm	2486	2582	2486	2582	2486	2582	2486	2582	2493	2589	2493	2589
4.34	Aisle width for pallets 800x1200 lengthways	A_{st}	mm	2385	2481	2385	2481	2385	2481	2385	2481	2394	2490	2394	2490
4.35	Turning radius	W_a	mm	1504	1600	1504	1600	1504	1600	1504	1600	1504	1600	1504	1600
6.4	Battery voltage, nominal capacity K_5		V/Ah	24/300	24/500	24/300	24/500	24/300	24/500	24/300	24/500	24/300	24/500	24/300	24/500
6.5	Battery weight, min.—max.		kg	195-310	345-405	195-310	345-405	195-310	345-405	195-300	345-405	195-310	345-405	195-310	345-405

* DIN battery will give same truck dimensions as for the large battery

Mast dimensions

Mast				Duplex Tele Panoramic View					Duplex HiLo					Triplex HiLo								
SWE145	h_{23}	Lift height ($h_{13}+h_3$)	mm	2350	2800	3300	3700	4150	2350	2500	2800	3300	3700	4150	3300	3700	3950	4150	4500	4800	5400	—
	h_3	Lift	mm	2260	2710	3210	3610	4060	2260	2410	2710	3210	3610	4060	3210	3610	3860	4060	4410	4710	5310	—
	h_1	Height, mast lowered	mm	1744	1969	2219	2419	2644	1744	1819	1969	2219	2419	2644	1671	1805	1888	1955	2071	2171	2371	—
	h_2	Free lift, ground to top of forks	mm	—	—	—	—	—	1256	1332	1482	1732	1932	2156	1194	1328	1410	1478	1594	1694	1894	—
	h_4	Height, mast extended	mm	2892	3342	3842	4242	4692	2891	3041	3341	3841	4241	4691	3816	4218	4467	4668	5016	5316	5916	—
SWE160	h_{23}	Lift height ($h_{13}+h_3$)	mm	2350	2800	3300	3700	4150	2350	2500	2800	3300	3700	4150	3300	3700	3950	4150	4500	4800	5400	6000
	h_3	Lift	mm	2260	2710	3210	3610	4060	2260	2410	2710	3210	3610	4060	3210	3610	3860	4060	4410	4710	5310	5910
	h_1	Height, mast lowered	mm	1744	1969	2219	2419	2644	1744	1819	1969	2219	2419	2644	1671	1805	1888	1955	2071	2171	2371	2571
	h_2	Free lift, ground to top of forks	mm	—	—	—	—	—	1256	1332	1482	1732	1932	2156	1194	1328	1410	1478	1594	1694	1894	2094
	h_4	Height, mast extended	mm	2892	3342	3842	4242	4692	2891	3041	3341	3841	4241	4691	3816	4218	4467	4668	5016	5316	5916	6520

Mast				Duplex Tele Panoramic View					Duplex HiLo					Triplex HiLo								
SWE200	h_{23}	Lift height ($h_{13}+h_3$)	mm	2150	2600	3100	3500	3950	2150	2300	2600	3100	3500	3950	3200	3600	3850	4050	4400			
	h_3	Lift	mm	2060	2510	3010	3410	3860	2060	2210	2510	3010	3410	3860	3110	3510	3760	3960	4310			
	h_1	Height, mast lowered	mm	1744	1969	2219	2419	2644	1745	1820	1970	2220	2420	2645	1671	1805	1888	1955	2071			
	h_2	Free lift, ground to top of forks	mm	—	—	—	—	—	1156	1232	1382	1632	1832	2056	1094	1228	1310	1378	1494			
	h_4	Height, mast extended	mm	2792	3242	3742	4142	4592	2792	2942	3242	3742	4142	4592	3816	4218	4467	4668	5016			

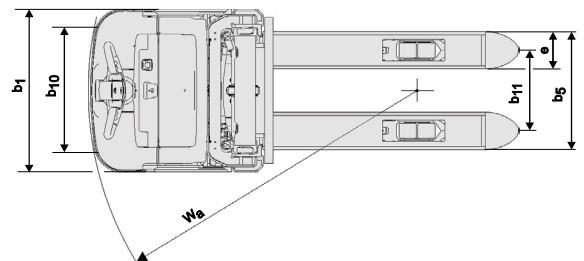
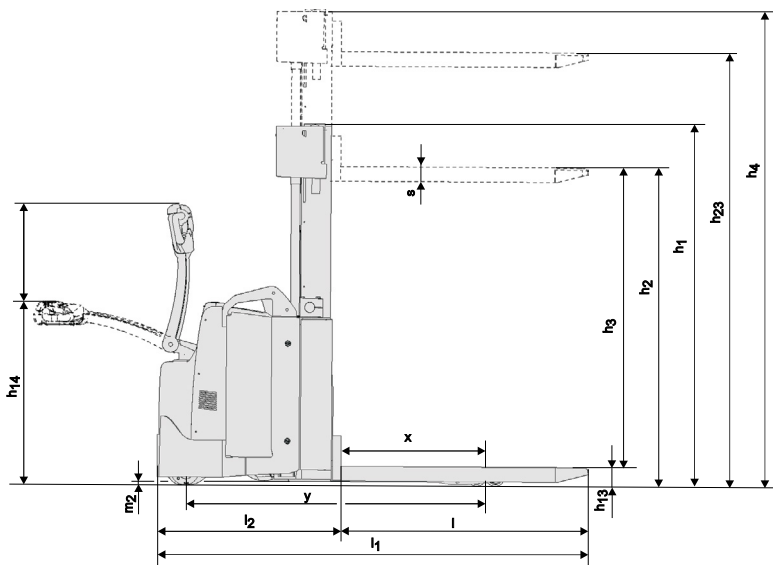

Truck features:

- BT Powertrak traction system
- Optimized Truck Performance
- Fingertip controls
- Electronic braking system
- Electronic speed control
- Operator safety
- Storage compartments
- Automatic switch-off
- Programmable performance
- Easy access for maintenance
- Sensilift
- Toyota I_site: truck fleet management system (option)
- Hydraulic oil for low temperatures (option)

